

## Igo T 130

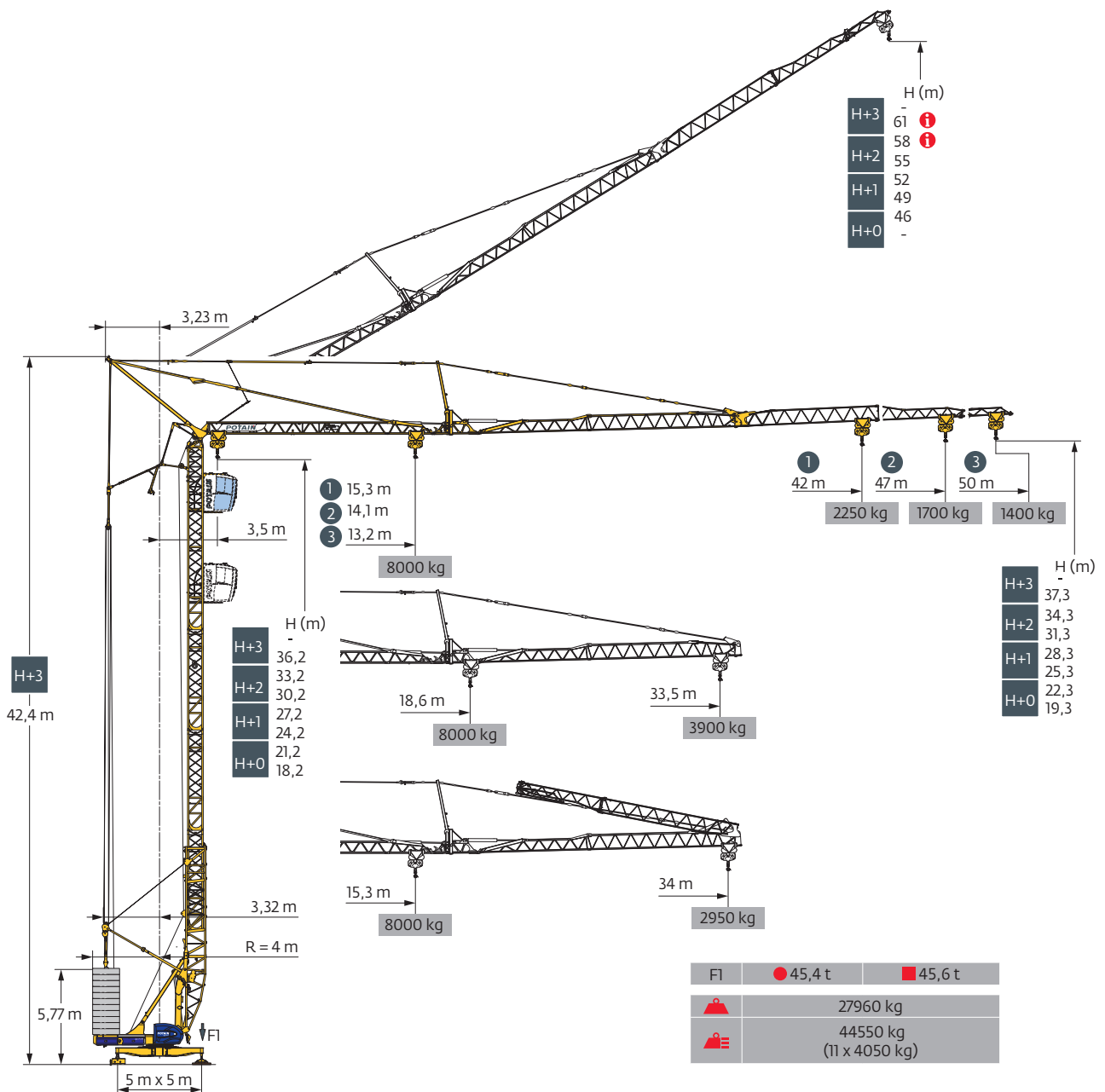

Courbes de charges / Lastkurven / Load curves / Curvas de cargas / Curve di carico  
 Curvas de carga / Кривые нагрузок

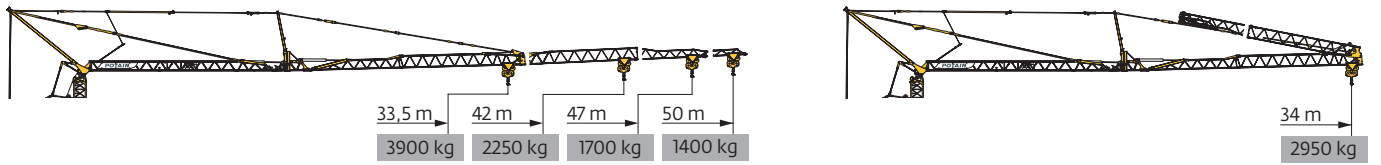

50 m	3,5	▶	13,2	14	16	18	20	22	22,7	23	24	26	28	30	32	34	36	38	40	42	44	46	48	50	m	
▲▲▲	▲▲▲		8000	7400	6200	5400	4700	4200	-	3900	3700	3400	3100	2800	2600	2400	2200	2050	1900	1800	1700	1600	1500	1400	kg	
										4000	3900	3700	3400	3100	2800	2600	2400	2200	2050	1900	1800	1700	1600	1500	1400	kg
47 m	3,5	▶	14,1	15	16	18	20	22	24	24,4	25	26	28	30	32	34	36	38	40	42	44	46	47	m		
▲▲▲	▲▲▲		8000	7400	6800	5900	5100	4600	4100	-	3900	3700	3400	3100	2850	2600	2450	2250	2100	2000	1850	1750	1700	kg		
											4000	3900	3700	3400	3100	2850	2600	2450	2250	2100	2000	1850	1750	1700	kg	
42 m	3,5	▶	15,3	16	18	20	22	24	25	26	26,7	27	28	30	32	34	36	38	40	42	m					
▲▲▲	▲▲▲		8000	7600	6500	5700	5100	4600	4300	4100	-	3900	3800	3500	3200	2950	2750	2550	2400	2250	kg					
												4000	3900	3800	3500	3200	2950	2750	2550	2400	2250	kg				
33,5 m	3,5	▶	18,6	20	22	24	25	26	27	28	30	32	32,8	33,5	m											
▲▲▲	▲▲▲		8000	7300	6500	5900	5600	5300	5100	4900	4500	4100	-	3900	kg											
													4000	3900	kg											

50 m																								
47 m	3,5	▶	15,3	16	18	20	22	24	26	26,7	28	30	32	34	m									
▲▲▲	▲▲▲		8000	7600	6500	5700	5100	4600	4100	-	3800	3500	3200	2950	kg									
42 m																								
▲▲▲	▲▲▲																							

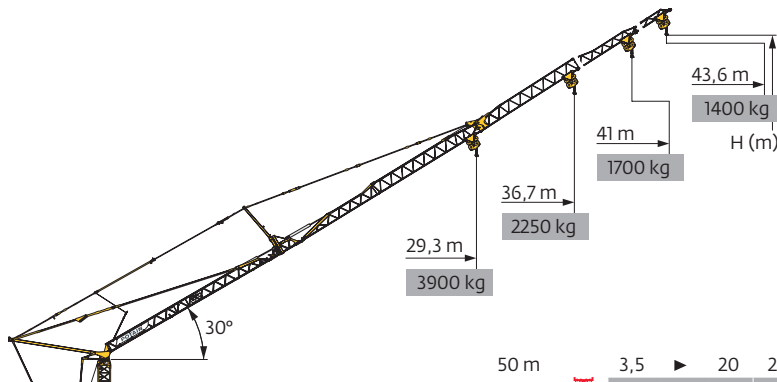

▲▲▲		50 m	47 m	42 m	33,5 m
H+3	!	61	59,4	-	-
H+2	!	58	56,4	-	-
		55	53,4	50,7	46,1
H+1		52	50,4	47,7	43,1
		49	47,4	44,7	40,1
H+0		46	44,4	41,7	37,1



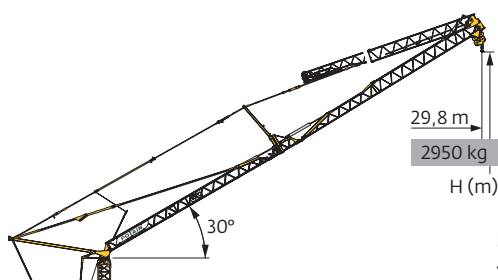



50 m	3,5	▶	20	22	24	26	28	30	32	34	36	38	40	42	43,6	m
▲▲▲	▲▲▲		4000	3500	3200	2850	2600	2350	2150	2000	1850	1700	1600	1500	1400	kg
47 m	3,5	▶	21,4	22	24	26	28	30	32	34	36	38	41	m		
▲▲▲	▲▲▲		4000	3900	3500	3100	2850	2600	2400	2200	2050	1900	1700	kg		
42 m	3,5	▶	23,5	26	28	30	32	34	36,7	m						
▲▲▲	▲▲▲		4000	3500	3200	2950	2700	2500	2250	kg						
33,5 m	3,5	▶	28,8	29,3	m											
▲▲▲	▲▲▲		4000	3900	kg											







▲▲▲	50 m
▲▲▲	47 m
▲▲▲	42 m
H+2	46,4
H+1	43,4
H+0	40,4

50 m															
47 m	3,5	▶	23,4	24	26	28	29,8	m							
42 m	▲▲▲		4000	3900	3500	3200	2950	kg							
▲▲▲	▲▲▲														

Mécanismes / Triebwerke / Mechanisms / Mecanismos / Meccanismi  
 Mecanismos / Механизмы

400 V - 50 Hz 480 V - 60 Hz												ch - PS hp	kW	
	<b>33 LVF 20 Optima</b>	m/min	3,2	16	34	53	63	1,6	8	17	26,5	31,5	29,5	22
		kg	4000	4000	4000	2000	1000	8000	8000	8000	4000	2000		
	<b>5 DVF 5</b>	m/min	15 - 30 - 39 (2000 → 8000 kg) 15 - 30 - 55 (200 → 2000 kg) 15 - 30 - 70 (0 → 200 kg)									5,4	4	
	<b>RVF 161 Optima+</b>	tr/min U/min rpm	0 → 0,8									7,5	5,5	
	<b>TVF 124</b>	m/min	25									2 x 4	2 x 3	

 IEC 60204-32	<b>kVA</b>
400 V (+10% -10%) 50 Hz / 480 V (+6% -10%) 60 Hz	 31 → 19 kVA  35 → 22 kVA 

**33 LVF 20 Optima**

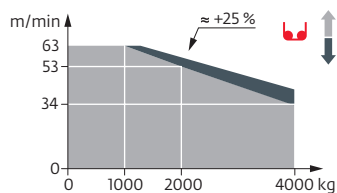

Montage / Montage / Erection / Montaje / Montaggio  
 Montagem / Монтаж

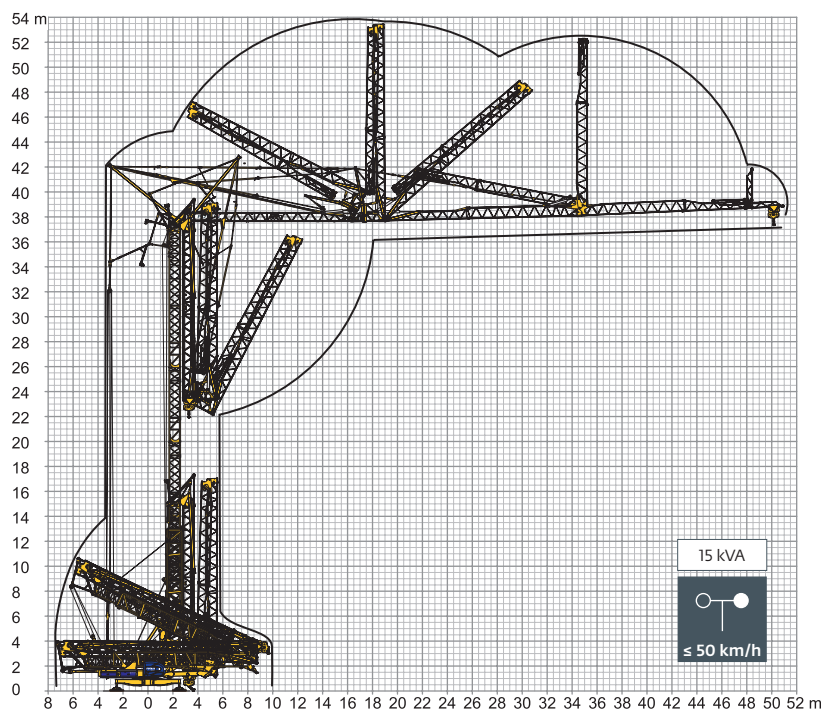

Transport / Transport / Transport / Transporte / Trasporto  
Transporte / Транспортировка

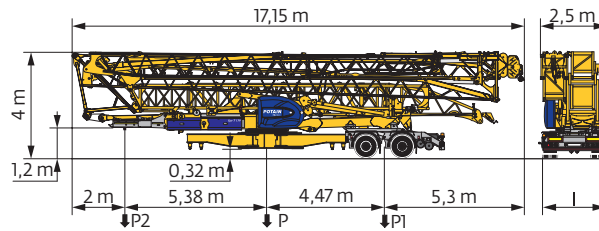

	km/h	l (m)	P (kg)	P1 (kg)	P2 (kg)
SL121/S215M	25	2,4	30100	19300	10800
SL122/J215M (EBS) RCE e2*2007/46*0493*01 WVTA e2*2007/46*0493*01	80	2,45	30000	19200	10800

	FR	DE	EN	ES	IT	PT	RU
R	Rayon de giration	Schwenk radius	Rear slewing radius	Radio de giro	Raggio di rotazione	Raio de rotação	Задний габарит
i	Nous consulter	Auf Anfrage	Consult us	Consultarnos	Consultateci	Consultar-nos	Проконсультируйтесь у нас
●	Réactions en service	Reaktionskräfte in Betrieb	Reactions in service	Reacciones en servicio	Reazioni in servizio	Reacções em serviço	Реакция при работе
■	Réactions hors service	Reaktionskräfte außer Betrieb	Reactions out of service	Reacciones fuera de servicio	Reazioni fuori servizio	Reacções fora de serviço	Реакция в покое
▲	Poids à vide, sans lest, sans trains de transport, avec flèche maxi. et hauteur standard.	Gewicht ohne Last, ohne Ballast, ohne Transportachsen, mit max. Auslager und Standardhöhe	Weight without load, without ballast, without transport axes, with max. jib and standard height	Peso en vacío, sin lastre, sin trenes de transporte con flecha y altura estandar	Peso a vuoto, senza assali di trasporto, con braccio max e altezza standard.	Peso em vazio, sem lastro, sem eixos de transporte com lança máxima e altura standard.	Вес без груза, без балласта, без осей для транспортировки, с максимальным вылетом стрелы и стандартной высотой
⚖	Poids total du lest	Ballast-Gesamtgewicht	Total ballast weight	Peso total del lastre	Peso totale della zavorra	Peso total do lastro	Общий вес балласта
□	Équipements standards	Standardausrüstungen	Standard equipment	Equipamiento de serie	Equipaggiamento standard	Equipamento de série	Стандартное оборудование
⊞	Équipements optionnels	Sonderausrüstungen	Options	Equipamiento opcional	Equipaggiamento in opzione	Equipamento opcional	Дополнительное оборудование (опция)
⬆	Levage	Heben	Hoisting	Elevación	Sollevamento	Elevação	Подъем
➡	Distribution	Katzfahren	Trolleying	Distribución	Ditribuzione	Distribuição	Перемещение по стреле
⦿	Orientation	Schwenken	Slewing	Orientación	Rotazione	Rotação	Поворот
➡	Translation	Kranfahren	Travelling	Traslación	Traslazione	Translação	Перемещение крана
⚡	Puissance requise	Erforderliche Leistung	Required power	Potencia Necesaria	Potenza richiesta	Potência Necessária	Потребляемая мощность
⊞	Fonction Power Control : vitesses treuils adaptées à la puissance disponible	Funktion Power Control: Geschwindigkeiten der Triebwerke werden an die verfügbare Leistung angepasst	Power Control Function: winch speeds adapted to the available power	Función Power Control: marchas de los cabrestantes adaptadas a la potencia disponible	Funzione Power Control: velocità degli argani adattate alla potenza disponibile	Função Power Control: velocidades de gincho adaptadas à potência disponível	Функция контроля мощности Power Control: регулировка скорости лебедок в зависимости от доступной мощности

⚠	Hauteurs sous crochet données moufle plaquée	Hakenhöhen werden mit plattiertem Haken angegeben	Hook heights given with plated pulley block	Altura bajo gancho con pasteca bloqueada	Altezza sotto gancio con bozzello in contatto con carrello	Altura ao gancho com o cadernal em contacto com o carrinho	Высота под крюком дана при условии, что крюковая подвеска соприкасается с кареткой
	Document commercial non contractuel	Unverbindliches Vertriebsdokument	This commercial document is not legally binding	Documento comercial no contractual	Documento commerciale non vincolante	Documento comercial não contratual	Этот коммерческий документ не является юридически обязательным
	Pour toute information technique se référer à la notice correspondante	Für technische Informationen, siehe die entsprechenden Anweisungen	For any technical information, please refer to the corresponding instructions	Para cualquier información técnica, ver la noticia correspondiente	Per tutte le informazioni tecniche fare riferimento al catalogo istruzioni	Para qualquer informação técnica complementar consultar as respectivas instruções	Для получения технической информации, см. соответствующие инструкции

